

OCTAVE

JUBILEE Mono

## FOREWORD

---

I wish to personally thank you for choosing OCTAVE products and congratulate you on your purchase of your new

*Jubilee mono power amplifier.*

Here at our head office in Karlsbad, right on the edge of the Black Forest, we have been designing and building high quality, long-lasting hi-fi equipment for over 20 years that will – quite literally – provide you with hours of musical pleasure for many years to come.

Today's loudspeakers and high-resolution source equipment continue to be very

demanding of amplifiers. As a result, achieving improved amplifier sound quality requires greater levels of technical innovation than ever before.

OCTAVE specializes in the ongoing development of upgradeable circuit designs and has earned a reputation over recent years as a world leader in the field of high-end tube amplifier design. Thanks to our years of experience and our in-depth understanding of amplifier technologies and their side effects, OCTAVE is able to achieve a musical quality and degree of reliability that seemed impossible or unaffordable only a few years ago

I trust that you will enjoy many hours of wonderful music with your OCTAVE amplifier.



Andreas Hofmann  
Chief Designer and Owner of OCTAVE Audio

## CONTENTS

		Page
	Foreword	
1.	Introduction .....	4
1.1.	What makes OCTAVE amplifiers special .....	4
1.2.	JUBILEE MONO product description .....	5
2.	Safety instructions .....	6
2.1.	Before you begin .....	6
2.2.	Placement.....	7
2.3.	Bevore powering up.....	7
3.	Operating components .....	8
3.1.	JUBILEE MONO rear panel.....	8
3.2.	JUBILEE MONO top control panel .....	10
4.	Getting started .....	12
4.1.	Unpack and check the contents .....	12
4.2.	Removing the grille.....	12
4.3.	Installing the power tubes .....	13
4.4.	Recommended procedure .....	14
5.	Bias measurement facility.....	16
5.1.	How the bias works .....	17
5.2.	How to set the bias .....	17
6.	The electronic protection system.....	18
6.1.	How the protection system works.....	18
6.2.	Identifying defective tubes .....	18
7.	Tubes .....	19
7.1.	Tube layout .....	19
7.2.	General procedure for changing tubes.....	20
7.3.	Tube service life.....	20
7.4.	Removing the protective assembly to change tubes.....	21
7.4.1.	Removing the protective grille to change output tubes .....	21
7.4.2.	Removing the side panel to replace driver tubes .....	22
8.	Troubleshooting .....	23
9.	Technical data and dimensions .....	24
10.	Technical data, diagrams .....	25
11.	FAQ .....	27

## 1. INTRODUCTION

---

### *1.1 What makes OCTAVE amplifiers special*

#### **Technology**

Tubes themselves do not themselves guarantee high quality sound. Only by partnering them with innovative electronics designed to create the optimum conditions for the tubes you can achieve consistently high sound quality.

OCTAVE amplifiers are equipped with a power management system whose design is unique. This electronic monitoring and protection system is comprised of a soft-start control and a protection system. An electronic control module regulates and controls all the functions of our amplifiers. When you switch it on, the soft start circuit ensures that the tube heaters and operating voltages are ramped up gently. If a fault should occur, the protection system steps in to switch the power off virtually instantaneously. This intelligent power management system guarantees total protection against all conceivable faults.

An optimized power supply, sophisticated power supply circuitry and the high load stability of the output stages ensure that every power amp and integrated amp bearing the OCTAVE name is capable of developing its full sonic qualities with virtually any loudspeaker.

Together, these measures deliver a supremely consistent sound quality and a dependability that is recognized as world class.

#### **Manufacturing**

Every OCTAVE amplifier is 100 percent "made in Germany". Our products are built individually by hand and thoroughly tested before they leave the factory. We design and make our own custom transformers. We maintain extremely high quality standards through close cooperation with specialist suppliers and by insisting on producing mechanical components in house on the latest CNC machines. The most important contributing factor, however, is the highly qualified and enthusiastic team working here at OCTAVE. The company owner, Andreas Hofmann, retains ultimately responsibility for the design and development of all OCTAVE products.

#### **Sound**

OCTAVE is fully convinced of the musicality and sonic superiority of tubes. But our experience tells us that using tubes does not automatically lead to audiophile sound quality. We appreciate that the sound characteristics of an amplifier are a result of the interaction of its component parts. This means that a high degree of technical skill must be applied to optimizing every detail in order to design a reliable amplifier that will maintain its characteristics over time and that will convince the critical listener over the long term that its reproduction of music is both honest and natural

## 1. INTRODUCTION

---

### 1.2 JUBILEE MONO product description

The JUBILEE MONO monoblocs are push-pull power amplifiers in pentode configuration. The power amplifiers produce approx. 280W at 2% THD.

OCTAVE power amplifiers have always set new standards.

Andreas Hofmann's RE 280 stereo power amplifier left traditional power amp technologies far behind when it was first introduced. It goes without saying that this amplifier - like all OCTAVE products since - was equipped with OCTAVE's proprietary Power Management and Protection electronics

#### POWER MANAGEMENT

The *Power Management* system monitors and controls the heating and supply voltages at switch-on. This is tremendously important in extending the service life of the tubes and maintaining a consistent sound. It also relieves the power supply components of the strain of handling huge surge currents at turn-on.

#### PROTECTION SYSTEM

Many manufacturers neglect to include electronic or even passive protection systems in their tube amps, which means that the life - and indeed the operational safety - of these amplifiers is greatly dependent on factors over which the user has no control. OCTAVE fits its power amplifiers with an *electronic protection system* as a matter of course.

#### LOAD STABILITY

The technical breakthroughs that set the original RE 280 apart were its *optimized input gain section and its power supply*. Indeed, it used a totally new power supply design, featuring double star-earthing and supply voltage isolation. The optimization of the input stages provided absolute immunity from influences such as the loudspeaker load, together with excellent phase stability for highly accurate push-pull operation and an extension of the usable frequency range up to 80kHz. From a sound quality point of view, these enhancements delivered a consistent tonal performance and independence from the impedance response and efficiency level of the speakers.

#### PENTODE DESIGN

With the JUBILEE MONO power amplifiers, Andreas Hofmann has gone one step further. While they have the same power management and optimized input stage as other OCTAVE power amps, they benefit from an innovative and enhanced output stage configuration. What is revolutionary about this new generation of amplifiers is that we have employed the classic, yet almost forgotten, *pentode configuration*.

The classic pentode configuration was quite commonly used in earlier power amplifiers. It offered the benefits of reliability and a relatively high power output. From a modern perspective, its disadvantage was reduced dynamic stability and a high level of distortion. These effects are not a direct result of the pentode itself, but rather of the circuitry employed at the time.

Andreas Hofmann has now developed a new design that eliminates the drawbacks of the classic pentode configuration. This innovative design involves the use of a second, separate power supply circuit for the auxiliary current needed for the pentode mode of operation. The characteristics of this enhanced pentode circuit are virtually ideal from both a sound quality and an engineering point of view. Among the welcome side effects of the enhanced pentode circuit are absolute immunity against interference and fluctuations in the supply voltage, and an ability to accept compatible output tubes.

#### BIAS

A further effective feature is the *bias measurement facility*.

Unlike the simpler class-A power amplifier type, AB amplifiers require adjustment of the negative grid bias to optimize the idle current for the power tubes. The setting can change as the tubes age and it must also be adjusted whenever tubes are replaced. Normally, this requires test equipment and a knowledge of what and where to measure, but with the JUBILEE MONO, you can check and adjust the bias any time the amp is on.

This adjustment has a huge influence on the sound quality and performance characteristics of an amplifier (see Bias diagram under Technical data).

## 2. SAFETY INSTRUCTIONS

### 2.1. Before you begin

Please read this Owner's Manual before you use the equipment for the first time.  
*Operating the amplifier without its protective grille is dangerous and not recommended.*

**In case of emergency: disconnect the plug from the mains supply.**

Never use an amplifier that is damaged or faulty. Make sure that it cannot be used until it has been repaired by a qualified service engineer.

Make sure that there is easy access to the IEC socket and power cord.

**Do not open the case**

There are dangerously high voltages and hot tubes inside this equipment. To avoid a burn or the risk of electric shock, never allow anyone except qualified personnel to open the case or remove the grille.

**Servicing and maintenance**

For reasons of safety, please ensure that servicing, repairs and other modifications to OCTAVE equipment are carried out only by a qualified technician. Fuses should be also be changed only by a qualified technician. Always replace fuses with ones of the same type and rating. If your amplifier requires servicing, please ship or take your equipment directly to OCTAVE or to one of our authorized service centres.

**Explanation of the warning symbols:**



The lightning flash with arrowhead symbol within an equilateral triangle is intended to alert the user to the presence of uninsulated 'dangerous voltages' within the product's enclosure that may be sufficient to constitute a risk of electric shock to persons.



The exclamation point within an equilateral triangle is intended to alert the user to important operating and maintenance instructions.



**Before connecting up**

Make sure that the voltage of your amplifier matches your electricity supply voltage.

**Grounding**

This amplifier is a protection class 1 device (with an earth conductor). To exclude the risk of electric shock in the event of a fault, the unit must be grounded. Use a three-core mains cable with a three-pin plug (supplied).

**Safety warning: Hot tubes!**

Warning: Remove the protective grille at your own risk. OCTAVE cannot accept any responsibility for injuries caused by the removal of this grille.

**Warranty**

OCTAVE can only guarantee the safety, reliability and performance of this unit if modifications and repairs are carried out by specialized personnel and if the amplifier is operated in accordance with the instructions contained in this manual.

## 2. SAFETY INSTRUCTIONS

---

### 2.2. Placement

#### 1. Location

OCTAVE equipment is designed strictly for use in a dry domestic environment. Do not use it in the open air or in damp environments!

Never place plants or liquid filled containers on your OCTAVE equipment. Take care that objects do not fall or liquids are not spilled into the enclosure. Should this happen, remove the mains plug immediately and have your amplifier checked by a qualified service technician.

Condensation may form if the amplifier is taken from a cold environment into a warm one. If you do this, wait until the amplifier has reached room temperature and is dry before switching it on.

Avoid installing the unit close to sources of heat such as radiators or anywhere that it may be in direct sunlight.

Do not operate the unit near flammable materials, gases or vapours. Avoid areas where there may be heavy accumulations of dust or where the unit may be subject to mechanical vibration.

Place your OCTAVE amplifier on a stable, even surface.

#### 2. Grille

Never operate the amplifier without the protective grille.

#### 3. Ventilation

Make sure that your amplifier has a good flow of air around it. If you intend to install your equipment in a cupboard or a shelf unit, ensure that there is at least a ten-centimetre gap between the ventilation slots and the walls all around the amplifier. The rear panel of cupboards should have ventilation holes to prevent heat build up. Do not rest the equipment on a soft surface such as carpet or foam sheeting.

### 2.3. Before powering up

1. In your own interest, please observe the Safety precautions and positioning advice (Chapter 2)
2. Before connecting your OCTAVE amplifier up, switch off all the other equipment that you intend to connect to it. This will avoid a source of possible problems when you plug these components in.
3. Connect the outputs from your preamplifier to the appropriate inputs on the JUBILEE MONO.
4. Connect your loudspeakers to your JUBILEE MONO amplifiers, making sure that you observe the correct polarity (positive on the amplifier to positive on the speakers).
5. Check that the amplifier is switched off before connecting the power cable to the wall socket.
6. The power switch for the JUBILEE MONO is located on the rear panel (see Chapter 3.1 - Operation).  
To fully disconnect the amplifier from the mains, you must unplug the power cable from the wall socket.   
Switching the amplifier off using the power switch is not sufficient. Make sure that access to the power switch is never obstructed.  
When you switch the amplifier on, the measurement display and the appropriate signal LEDs illuminate (see Chapt. 4 Setting up).  
The unit is ready for use after about three minutes.
7. Check that the volume control is not set at maximum before playing music through the amplifier.
8. Switch the other components on in any order.

### 3. OPERATING COMPONENTS

#### 3.1. JUBILEE MONO rear panel

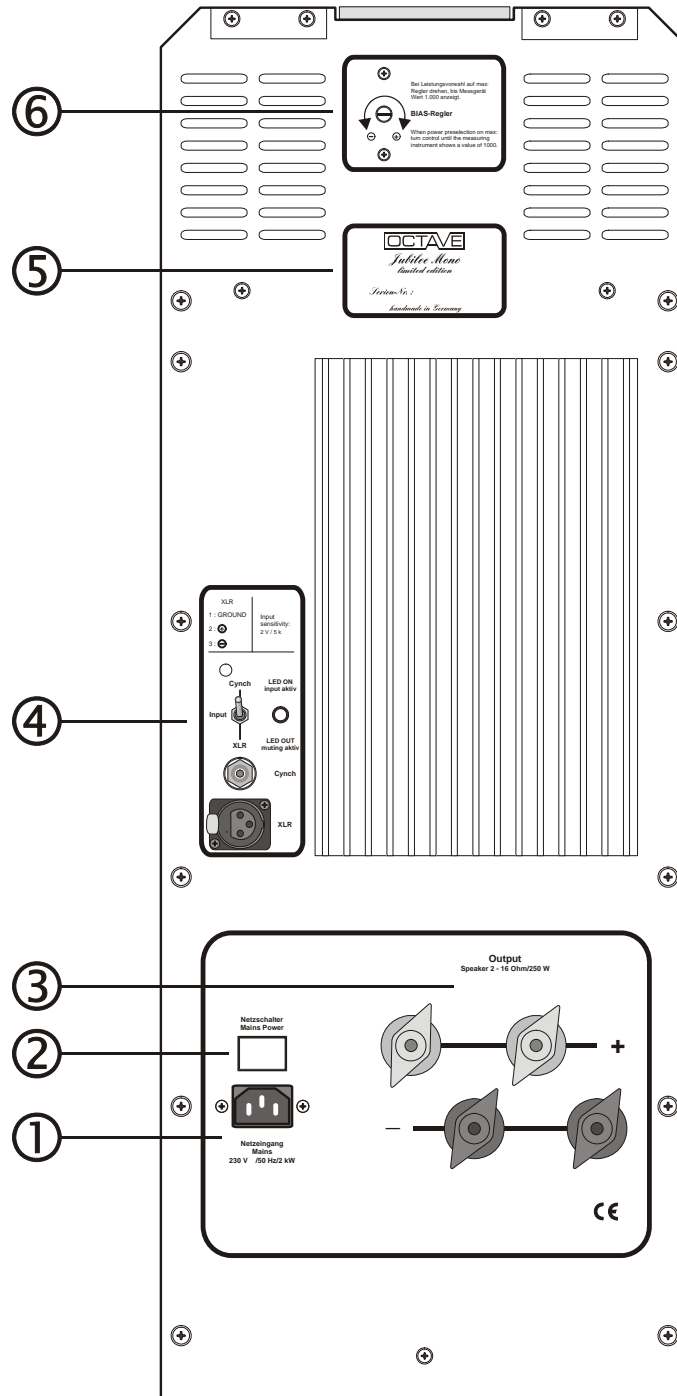



### 3. OPERATING COMPONENTS

① **Power inlet**  
AC input, IEC socket

② **Power switch**  
The plug on the power cord should be viewed as a disconnect device. For this reason, please ensure that this plug is easily accessible at all times. Selector knobs and electronic switches are not suitable for use as disconnect devices.

③ **Loudspeaker outputs**  
Loudspeaker terminals. When connecting the power amplifier to your speakers, take care to connect the red terminal on your amplifier to the positive terminal on your speakers. The blue (negative) terminal connects to the negative terminal on your speakers. The outputs are connected in parallel and are identical.

④ **Input panel**  
The power amplifier is equipped with an RCA phono and an XLR input. You can select the appropriate input using the input toggle switch. You can also connect both inputs at the same time and switch between them.

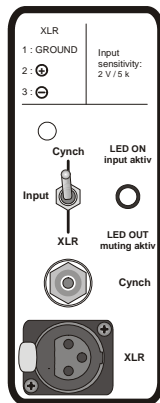

XLR pin connections:  
1 = ground, 2 = +, 3 = -  
The LED next to the switch illuminates when the input is active  
(see Muting facility on top control panel)

⑤ **Model identification plate**  
Model and serial number

⑥ **Bias adjustment**  
This control sets the bias for all eight power tubes simultaneously. This is done by setting a value of 1000 for one of the eight tubes with the bias setting active in the top control panel.

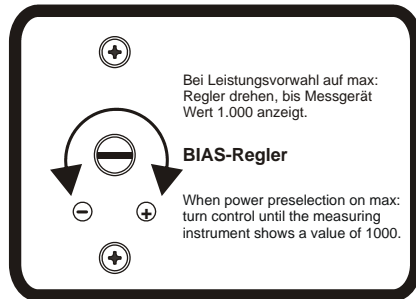

If the eight power tubes have been properly selected, they should not deviate more than 15 percent from each other. The value displayed in the meter will be between 850 and 1000. (see also Chapters 4 and 5)

### 3. OPERATING COMPONENTS

#### 3.2. JUBILEE MONO top control panel

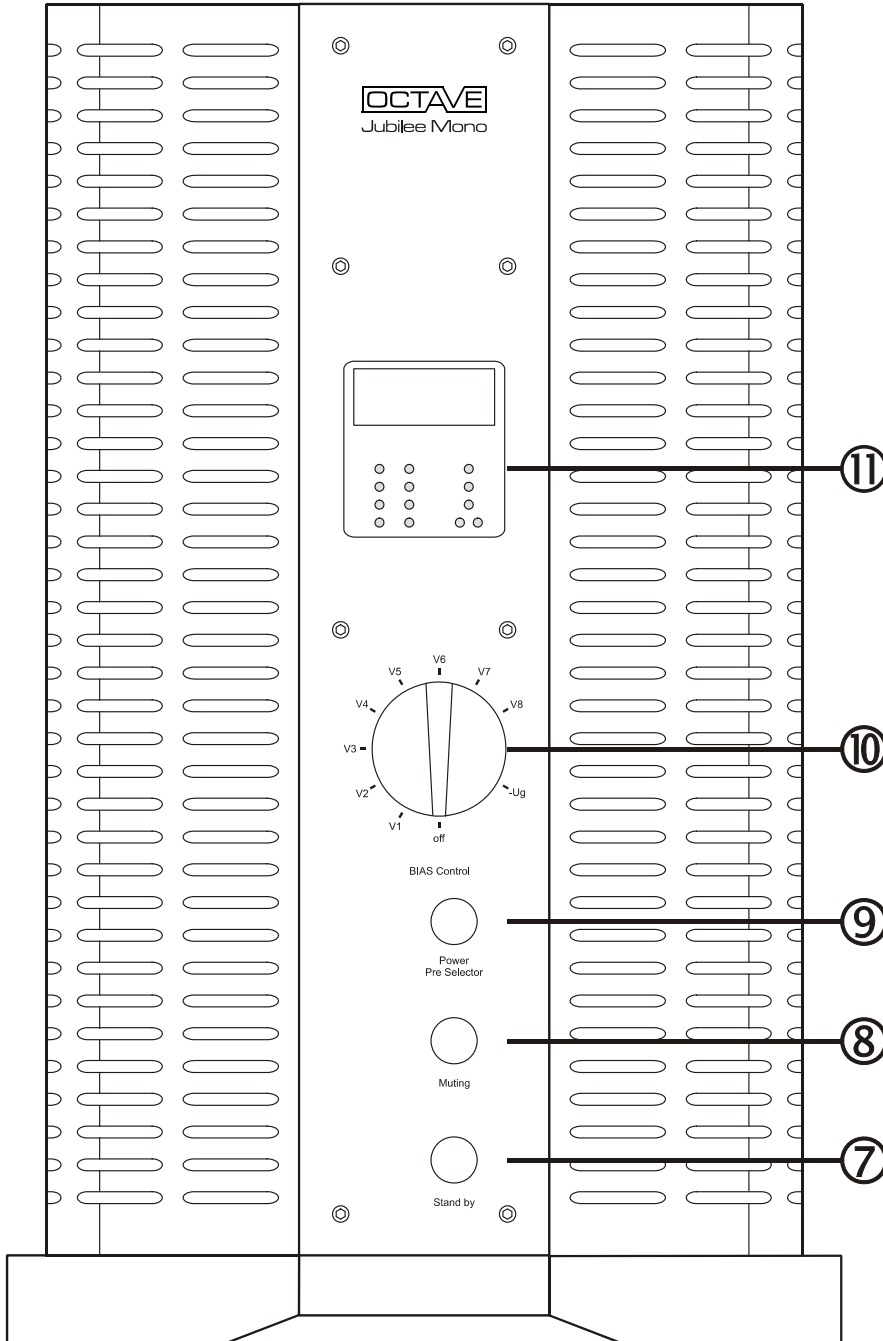

### 3. OPERATING COMPONENTS

⑦ **On/Standby (Power) button**

The button in the top control panel can only be used to switch the amplifier on when the power switch ② has been turned on at the rear of the unit. 000 will appear in the display ⑪. During the switch-on phase, the yellow A and green B LEDs illuminate in the display (see Chapt. 4).

⑧ **Muting button**

This button disables the inputs on the power amplifier. The green LED B lights up in the display and the LED next to the input selector switch (④ input) goes out.

You can now connect RCA phono or XLR leads without having to switch the amplifier off.

⑨ **Bias button**

This button reduces the bias current to a third of its nominal value.

*The low bias setting is useful when the power amplifier is to be used at low volume or as a specific reference setting during the activation phase for checking the correct operation of the unit and for checking the tube parameters (see Chapt. 4, section 7).*

Overall power consumption is also reduced in this setting, which produces less heat.

The low bias setting is indicated by the green LED C on the display; the high bias setting is indicated by the blue LED D.

⑩ **Bias measurement selector switch**

This selector switch simplifies checking and adjusting the idle current of the eight output tubes. The readings are displayed in the digital meter.

⑪ **Display**

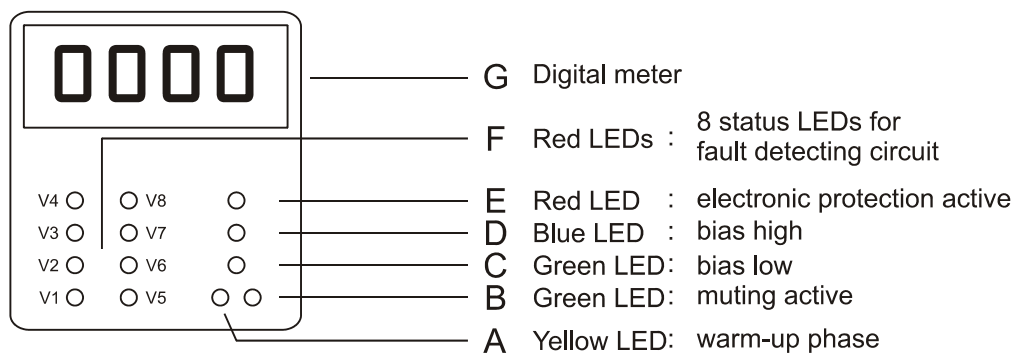

## 4. GETTING STARTED

### 4.1. Unpack and check the contents

#### Package contents for two Jubilee Monos:

1. 16 power tubes 6550 C packed separate (8 for each Mono)
2. Service bag content:
  - a) Owner's manual with warranty
  - b) 2 x 4 spare tubes for each mono
  - c) 8 x equipment feet for replacing the wheels
  - d) gloves
  - e) Tools: 3 screwdrivers:
    - ◆ 1 x 3 mm flat-bladed screwdriver for adjusting the bias
    - ◆ 1 x 2,5 mm Allen key for removing the cover and the side panel
    - ◆ 1 x Allen key size 5 for installing the equipment feet

### 4.2. Removing the grille

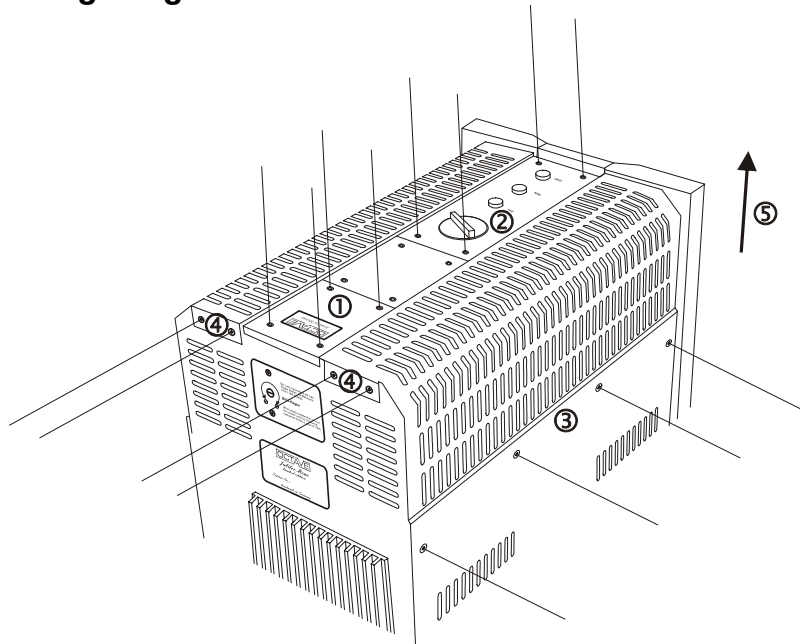

1. Please don't connect the amp to the mains before the tubes are installed because of your own safety.
2. Undo the eight M3 socket head screws on the top cover panels ① and ②. Lift both panels to remove them. You do not need to remove the Perspex cover from the display.
3. Unscrew the four Torx screws ③ several turns using the Torx screwdriver supplied. These do not need to be unscrewed completely.
4. Unscrew and remove the two Philips screws (Philips 2) ④ on the rear of the amplifier.
5. Remove the protective grille by lifting at the right or left. ⑤

## 4. GETTING STARTED

### 4.3. Installing the power tubes

Tubes for Jubilee Mono 1:

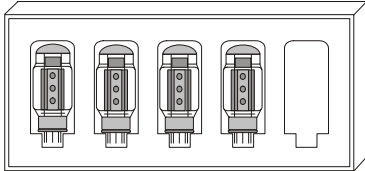

Tubes for Jubilee Mono 2:

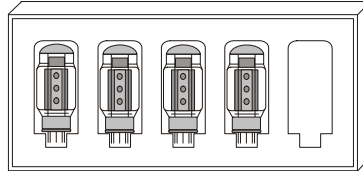

+

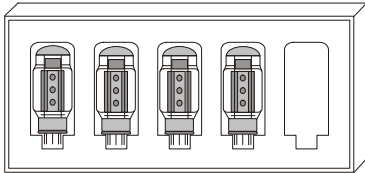

+

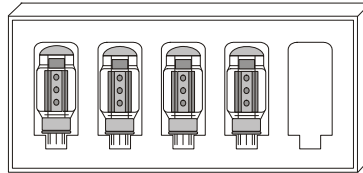

Jubilee Mono 1



Jubilee Mono 2

You can mix up the 8 tubes for each Jubilee Mono because they are precisely matched and have nearly the same value.

**But please don't mix up the tubes from Jubilee Mono 1 to Jubilee Mono 2!**

Insert the power tubes into their sockets. Ensure that you correctly locate the anti-rotation lug on each of the tubes.

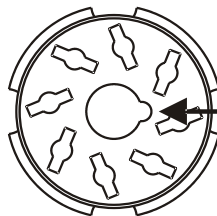

Anti-rotation recess  
on the tube socket

## 4. GETTING STARTED

### 4.4. Recommended procedure



**Please note:** Before you use your amplifier for the first time, we **strongly recommend** that you follow the procedure described in the following eight points, even if your dealer has already set the amplifier up for you. By checking these eight points, you will also familiarize yourself with the controls of your amplifier. It will also eliminate the possibility of user error.

1. Connect the power amplifiers to an earthed wall socket using the 3-core power cable supplied.
2. Connect your loudspeakers and preamplifier to the rear panel of the amplifiers. ③ + ④
3. Press the power switch above the power inlet socket on the rear panel. ②

#### Start phase

4. Now press the power button ⑦ on the top of the amplifier.  
The unit will be switched on electronically via an internal relay and you will hear a clicking sound as the relay switches in. LED A and LED B light up in the display and - depending on the position of the bias switch - LED C or LED D. The display meter reads 000.  
The start phase takes approx. 4 - 5 minutes. LED A remains lit during this time. Since the amplifier is muted by default, LED B illuminates regardless of the position of the muting switch. Pressing the muting button makes LED B slightly brighter.  
It is not possible to play music during the start phase. The Bias switch should now be set to "low"; the green LED C illuminates.
5. After about two minutes, you will hear the sound of a second relay cutting in. This indicates that the output tubes are being heated up and they will begin to glow.

6. LED A goes out once the start phase has been completed. Your amplifier is now ready for use. You must now deactivate the muting function so that LED B is extinguished.

#### Functional test: Bias low

7. Before listening to music, check the amplifier for correct operation and make adjustments if required.  
Check the operation of the tubes and the amplifier itself using the Bias measurement selector switch ⑩.

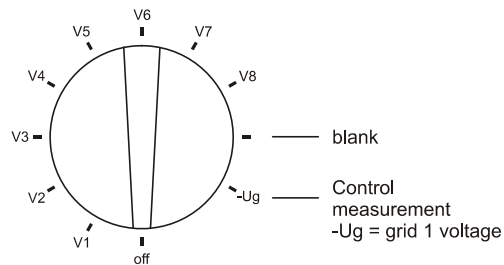

#### Switch in position V1:

The bias current in output tube V 1 is measured with the switch in this position, and the reading is shown in the meter G.  
**Bias low reading: approx. 230**

Turn the knob to check all eight tubes. All eight tubes will give a similar reading. If all the tubes show a reading that is too high, use the screwdriver supplied to turn the Bias control ⑥ on the rear panel toward the minus mark until you get a reading of approximately 230.

If any of the eight tubes read 0 or well above 230 (> 350), the tube in question must be replaced.

## 4. GETTING STARTED

---

### **Functional test Bias high**

After checking the readings in the low setting, you can now activate Bias high.Ⓢ. Bias high is indicated by the blue LED D. Slowly increase the figure shown in the display for V 1 - V 8 until you get a bias current reading between 800 and 1000. Check the tolerance of each of the eight tubes by selecting them one by one.



Deviations of up to 10 to 15% between individual tubes are acceptable. If a reading settles at substantially higher than 1000, you can correct for this using the Bias

control Ⓢ.

**Bias high reading: 1000**

***This is now the default setting of the bias control, which should be maintained.***

### **Functional test, muting**

If all values are correct, the muting function will now activate. When the muting function is active, not only are the inputs short-circuited to allow signal cables to be connected; the current to the power tubes is also reduced to 0.

When the selector switch points to an output tube, you will therefore notice that the meter will read < 100. This dual function allows you to gently burn in new tubes or tubes that have been in storage for some time. The meter reading will gradually increase when you switch the muting function off. This soft start-up prevents pops and regulation noise being sent to your speakers.

When the muting function is active, the green LED B illuminates in the display and the LED next to the rear panel input selector switch goes out to indicate that the amplifier has been muted.Ⓢ

### **End of activation phase**

8. When you have confirmed that the amplifier is operating correctly and have made any necessary adjustments, you can go ahead and use the amplifier. However, the amplifier will not pass a signal to the loudspeakers if the red LED E illuminates during the start phase or while listening to music. This LED lights up to warn you that the electronic protection circuit has switched the amplifier off. (see Chapt. 5)

## 5. BIAS MEASUREMENT FACILITY

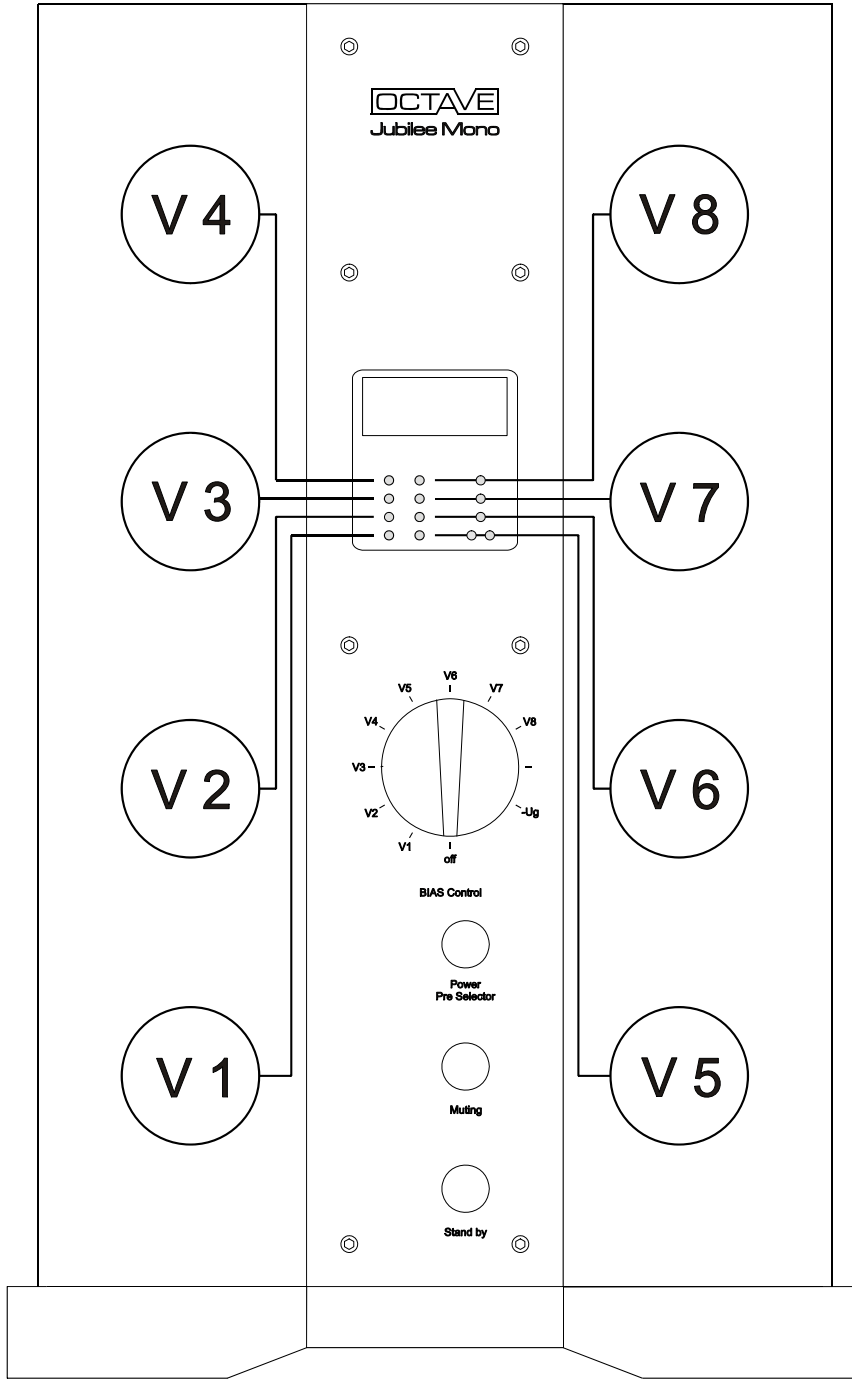



## 5. BIAS MEASUREMENT FACILITY

---

### 5.1. How the bias works

The bias measurement facility makes it easy for you to check and adjust the idle current of the output tubes. Getting the bias setting right for all eight tubes is critical both for the sound of the power amplifier and for the service life of the tubes. This is why we have incorporated a bias measurement facility into the Jubilee monoblocs that allows you to set the bias yourself without the need for test equipment.

The protective screen does not have to be removed to do this.



The driver tubes inside the unit require no adjustment.

**Changes caused by aging of the tubes can be compensated for. The sound of the amplifier remains constant throughout the service life of the tubes.**

### 5.2. How to set the bias

Make sure that no signal is playing through the amplifier when you are adjusting the bias. The preamplifier should be switched off, although you do not need to disconnect the loudspeakers.

#### Procedure

1. The amplifier must be operated for at least 15 minutes to allow the tubes to reach their operating temperature. The adjustment is made in the Bias high setting.
2. Turn the bias measurement selector switch  to position V 1. The meter in the display will now read 700 (typically). Now turn the selector switch to V2, V3 and so on, through to V8. If the tubes have selected properly, each one will read  $700 \pm 15\%$ . 700 is slightly too low for the Bias high setting. The value should be increased to 1000
3. To do this, slowly turn the Bias control  on the amplifier rear panel clockwise toward the + mark. The value in the display will now increase. You can now check once again to see whether the readings for all eight tubes remain within the 15% tolerance range.

#### Special cases: Faulty tubes

4. You should remove any tube that reads outside tolerance or that fails to provide a stable reading after an initial period.
5. Any tube that reads 0 is defective and non-functional and must be replaced. Tubes showing a reading of 0 cannot be corrected by turning up the bias control.
6. If you notice a constantly rising reading on a tube, accompanied by the red LED E turning on at some point, this means that the power amplifier has switched itself off electronically. The readings for tubes V 1 - V 8 fall to 0. No adjustment is now possible.  
See Chapt. 6 Electronic protection

## 6. ELECTRONIC PROTECTION

### 6.1. How it works

Your amplifier's electronic protection system constantly monitors the operating current in the eight output tubes. If a preset maximum value is exceeded, power to the amplifier is cut off. This is indicated by the red Off LED. Of course, certain parts of the amplifier remain active when the protection cuts in, but bias adjustment is no longer possible - neither is it possible to play music under these circumstances. The electronic protection prevents overload of the tubes due to short-circuiting of the speakers or similar fault conditions. It also protects the power amplifier from the type of damage that certain tube faults can cause. Once the protection system has been tripped, it will remain active. You can only deactivate it by switching the amplifier off and on again - assuming, of course, that you have fixed the problem.

### 6.2. Identifying defective tubes

There are a number of reasons why tubes become defective.

#### 1. Breakage of the heater filament and internal contact problems

The tube's operating current normally drops to 0 when this fault occurs. Because of this, the electronic protection does not cut in. You can confirm this type of fault using the bias measurement facility while the amplifier is on. The problem tube will give a very low reading, or a reading of 0. Use the rotary selector switch to determine the location of the faulty tube. Then replace it (see Chapt. 7 Replacing tubes).

#### 2. Leaking glass envelope

To function properly, the inside of a tube must be a vacuum. Tiny hair cracks or defects in the glass envelope can allow small amounts of air to enter the tube. Initially, the effect is not noticeable. However, the bias measurement system allows you to trace such tubes because they produce a strongly fluctuating reading. Larger amounts of air penetrating the tube cause the shiny silver surfaces in the glass envelope to turn white. The readings for these tubes will be around 0. Once air has

entered the tube, the heater filament will burn out. This type of tube failure will not result in damage to other parts of the amplifier. You should replace any tubes suffering from this problem (see Chapt. 7 Replacing tubes).

#### 3. Signs of tube aging

It will normally be necessary to re-bias output tubes at some time during their service life to bring the idle current back to the prescribed setting. Depending on the age, quality, type of construction and the materials used inside the tube, the bias setting may be quite different after a number of years from that of a brand new tube. To monitor this effect, we have included a Control measurement setting in the bias measurement system. The meter shows the setting required to achieve the correct idle current. With 'bias high' and new tubes, the value is around - 400 (for engineers: - Ug1 = - 40 V). The amount of adjustment needed depends greatly on the manufacturing techniques used by the tube manufacturer. You can safely use the tubes in your amplifier until there is insufficient adjustment remaining to set the bias correctly. The specified limits for adjustment are between - 200 and - 800 on the display.

#### 4. Uncontrollable rise in tube idle current

Mechanical faults, particularly loose connections, can lead to an increase in tube idle current. This increase can be very rapid and is sometimes accompanied by sparking inside the tubes. When such a fault occurs, the amplifier's electronic protection reacts within < 0.2 seconds. The amplifier will switch itself off, making it impossible for the user to locate the tube that has caused the problem. For this reason, we have incorporated a fault detecting circuit in the amplifier. This subsystem monitors the output tubes alongside the electronic protection system. However, the fault detecting circuitry will recognize which tube is responsible for triggering the protection system and display this information via the 8 status LEDs F in the display. Each LED is allocated to a single output tube. The LED for the faulty tube will remain lit even after the electronic protection has switched the amplifier off. You should replace this problem tube (see Chapt. 7 Replacing tubes).

## 7. TUBES

### 7.1. Tube layout

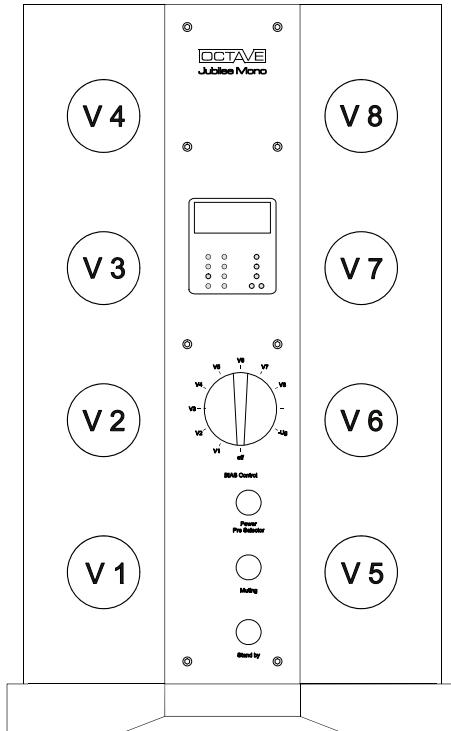

#### Output tubes:

V1 - V8: KT 88 or 6550

You can also use pin-compatible tubes such as the KT 66 or EL 34.

**The output tubes must be selected.**

**Selection criterion:** identical cathode current and grid bias voltage

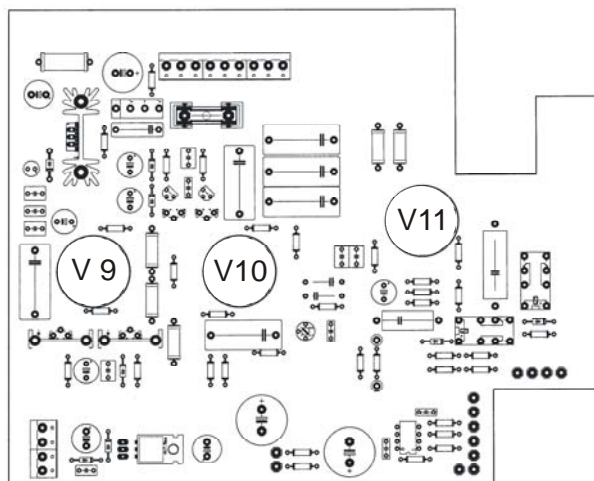

#### Driver tubes:

V9 - V11: ECC82

V9: Output stage driver

V10: Main amplifier tube

V11: Input tube

The board is located on the rear panel inside the amplifier. (see Chapt. 8.4.)

## 7. TUBES

### 7.2. General procedure for changing tubes

Tubes should only be replaced by qualified personnel.

#### **General procedure:**

Switch the amplifier off and disconnect the plug from the mains supply. Allow it to cool down for 10 minutes.

1. Take off the protective grille. see 8.3. and 8.4.
2. Remove the old tubes by carefully pulling out them upwards.
3. Fit the new ones.  
Insert the power tubes into their sockets as shown on the tube layout. Ensure that you correctly locate the anti-rotation lug on each of the tubes.

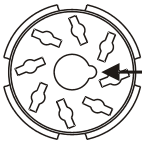

Anti-rotation recess  
on the tube socket

#### **Adjustment after the tube changing**

##### New driver tubes

Replacement driver tubes require no adjustment.

##### New output tubes:



1. When you have successfully replaced the necessary tubes, replace the grille and panels.
2. **Before you switch the amplifier back on after fitting new output tubes, turn the bias adjustment control counter-clockwise toward minus as far as it will go.** The control is a ten-turn potentiometer, i.e. it takes ten revolutions to go from the maximum to the minimum setting.
3. Switch the amplifier on, carry out the checks described in Chapt. 4, and adjust the bias as required.
4. Your amplifier is now ready for use. Depending on the type, age and manufacturer of the tubes, you may need to readjust the settings in the first few weeks.

### 7.3. Tube service life

- Thanks to the protection circuits and soft start electronics, the output tubes used in your amplifier should achieve an average service life of 3 to 5 years. We cannot, however, guarantee the service life of the tubes. These are average values, which will vary with the type and manufacturer of the tubes.

The internal protection and soft start circuits cannot prevent tube faults. They are designed to minimize the stress on the amplifier and to protect it should a fault develop. You can select tubes by measuring their characteristics but this does not guarantee that they will last for a long time. Indeed, it is impossible to predict

how long the output tubes will last.

A well-made tube has a life expectancy of between 3 and 5 years. However, it remains impossible to detect certain weaknesses in the structure of a fully functional tube. The protection circuits in the power amplifier will also protect the unit against the damage that a defective output tube could cause.

- Driver tubes can last for 10 years or longer.
- Because tubes have different service lives, you will never have to renew the entire tube complement at the same time.
- Please note that some tubes need a long time (up to 300 hours) to achieve their optimum sound quality.

## 7. TUBES

### 7.4. Removing the protective assembly to change tubes

#### 7.4.1. Removing the protective grille to change output tubes

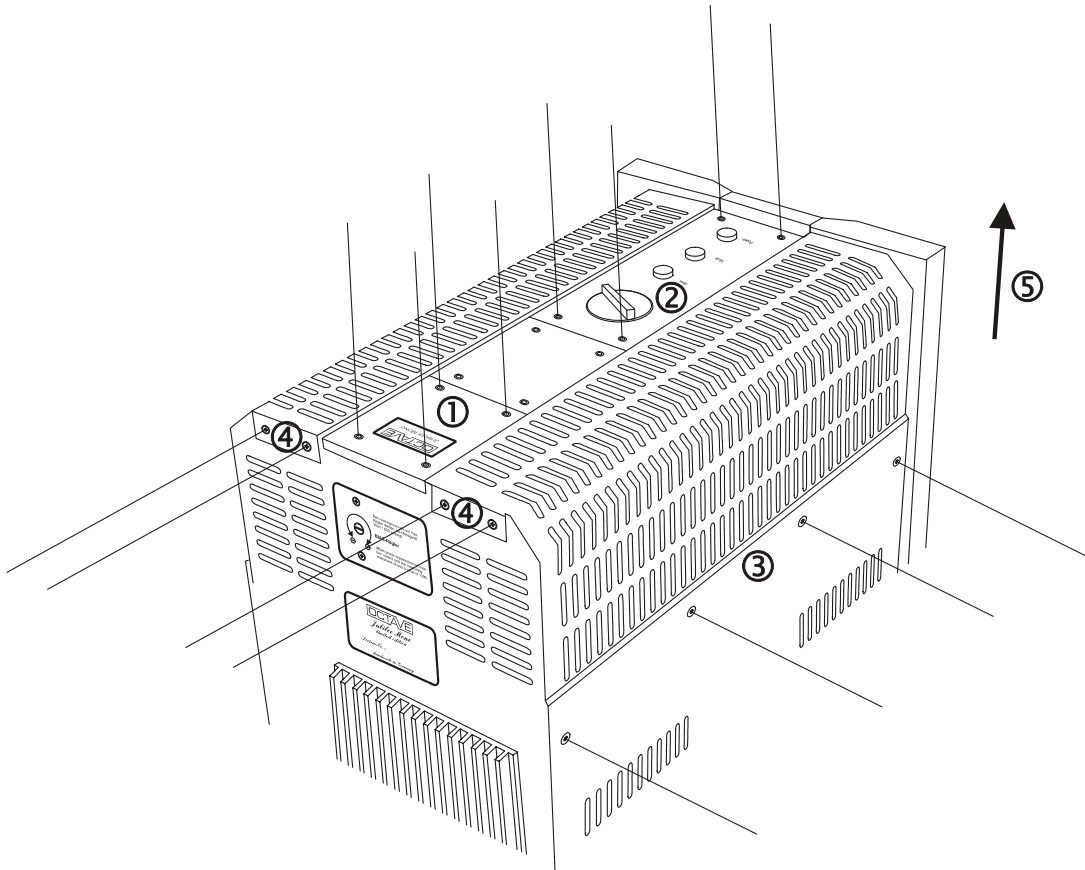

**Operating the amplifier without its protective grille is dangerous and not recommended. Tubes should only be replaced by qualified personnel.**

1. Switch the amplifier off using the on/off switch and disconnect the power cord. Wait for 10 minutes until the amplifier and the output tubes have cooled down.
2. Undo the eight M3 socket head screws on the top cover panels ① and ②. Lift both panels to remove them. You do not need to remove the Perspex cover from the display.
3. Unscrew the four Torx screws ③ several turns using the Torx screwdriver supplied. These do not need to be unscrewed completely.
4. Unscrew and remove the two Philips screws (Philips 2) ④ on the rear of the amplifier.
5. Remove the protective grille by lifting at the right or left. ⑤

## 7. TUBES

### 7.4. Removing the protective assembly to change tubes

#### 7.4.2. Removing the side panel to replace the driver tubes.

Driver tubes normally do not require replacement (see Chapt. 7.3.)



*Operating the amplifier without the side panel is dangerous and not recommended! Tubes should only be replaced by qualified personnel. There are a number of points inside the amplifier that can cause a fatal electric shock if touched.*

1. Switch the amplifier off using the on/off switch and disconnect the power cord. Wait for 20 minutes until the amplifier and the tubes have cooled down.
2. Remove the right side panel (viewed from the front).
3. To prevent the side panel from slipping and damaging the screws, support the panel at both front and rear using two paperback books.
4. Use the Torx screwdriver supplied to remove the 13 Torx screws from the side panel. Work from the top down and remove screw **S** last.
5. You can now remove the side panel.
6. Replace the tubes as required in accordance with the tube layout. V11 is the tube closest to the right side panel.

Step 1

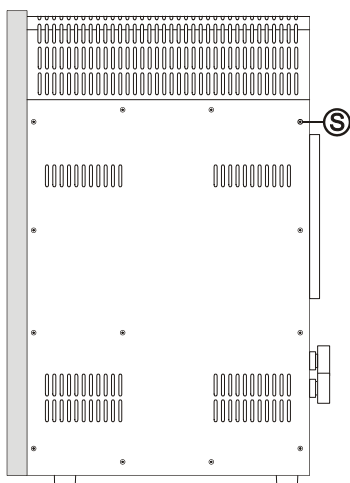

Step 2

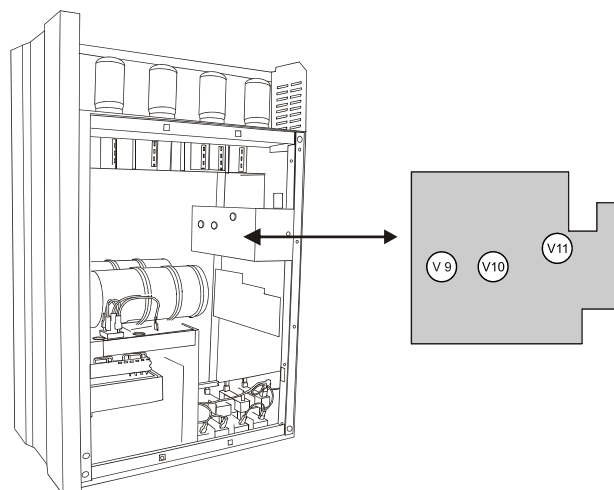

## 8. TROUBLESHOOTING

---

### ■ **Noise and hum**

Hum in an audio system is often caused by several system components being grounded separately. It is particularly common in systems containing tuners, VCRs or satellite receivers connected to an aerial, where a hum loop may be introduced via the aerial input. Although the Jubilee Mono is also grounded, it is equipped with a special technology that reliably prevents ground loops. Should an earth loop nevertheless develop via a tuner or television aerial, we strongly recommend that you use a signal-isolating filter on the aerial connection. This will eliminate all ground loops.

#### **Hum when connecting the power amplifier via XLR:**

When connecting the power amplifier to a preamplifier using XLR cables, make sure that all three pins are connected at both ends.

### ■ **Switching interference**

Older fridges and 12 V halogen lamps can cause cracking through the loudspeakers when they switch on and off.

Solution: the only solution is to run your system from a single distribution board - if possible, one that incorporates a mains filter. Under certain circumstances, fitting an inexpensive industrial filter in the power line of your refrigerator may be a more effective solution.

### ■ **The channels are unbalanced and/or there is distortion at certain frequencies**

The problem of channel imbalance or distortion in one channel is unlikely to be caused by defective tubes. The most frequent causes are cables and faulty recording devices.

Solution: Unplug all non-essential components/cables from your preamp. Swap channels to check your speaker and interconnect cables. You will generally be able to locate the fault if it changes channel or disappears altogether.

### ■ **Tube faults**

see Chapt. 6.2. Identifying defective tubes

## 9. TECHNICAL DATA AND DIMENSIONS

### In- and Outputs

Inputs	1 x RCA, 1 x XLR
Outputs	2 x Loudspeaker output

### Amplifier

Power output	250W into 4 ohms
Frequency response	10Hz - 80kHz / $\pm 0.5$ dB
Total harmonic distortion	< 0.1% at 10W into 4 ohms
Signal-to-noise ratio	> 103 dB
Minimum load impedance	2 ohms
Gain/input sensitivity	+ 30dB / 1.5V

### General

Power consumption	320W minimum, 600W at full power
Weight:	65 kg per monobloc
Standard accessories	Power cord, 3 screwdrivers, spare tubes KT88/6550
Dimensions	Overall dimensions in mm:

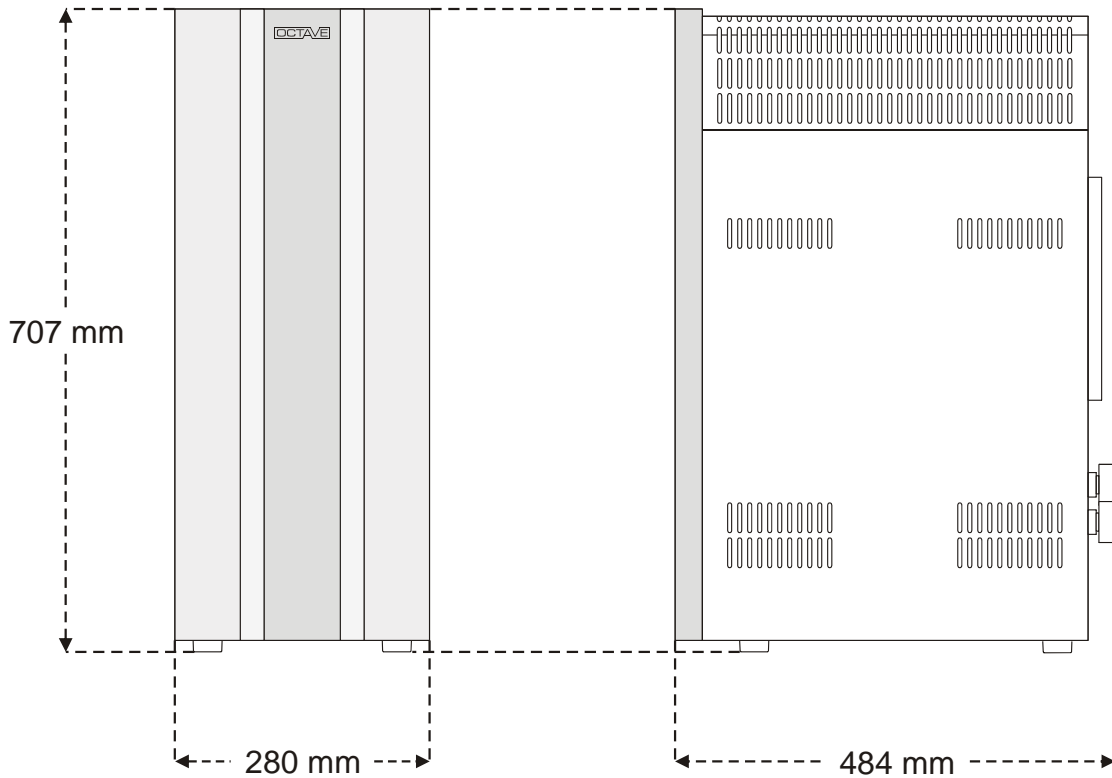



## 10. TECHNICAL DATA, DIAGRAMS

Distortion in % at 10W into 4 ohms between 30Hz and 20kHz  
at a variety of bias settings

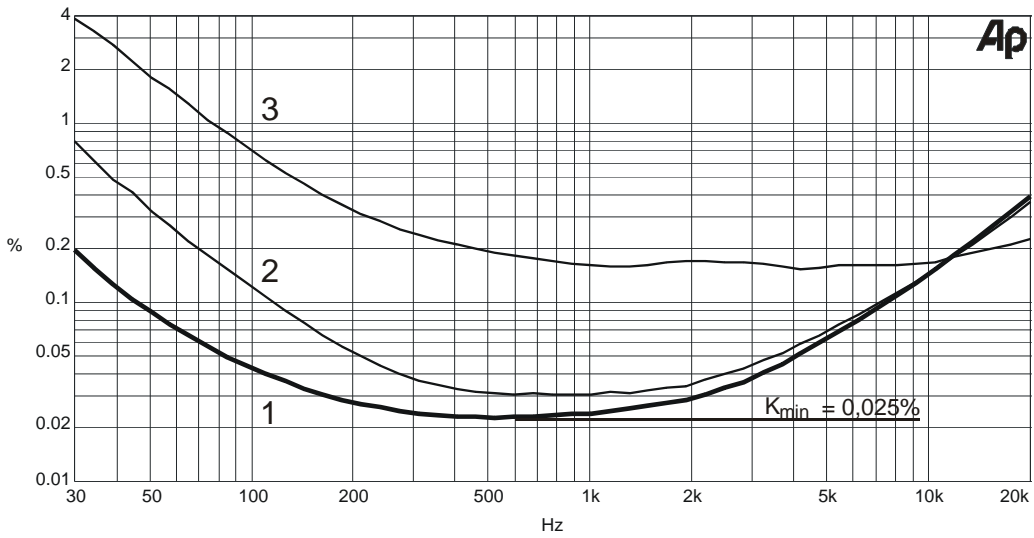

- Curve 1: Bias adjusted correctly; bias high with selected tubes
- Curve 2: Distortion curve with unselected tubes
- Curve 3: Distortion curve bias low

Frequency response

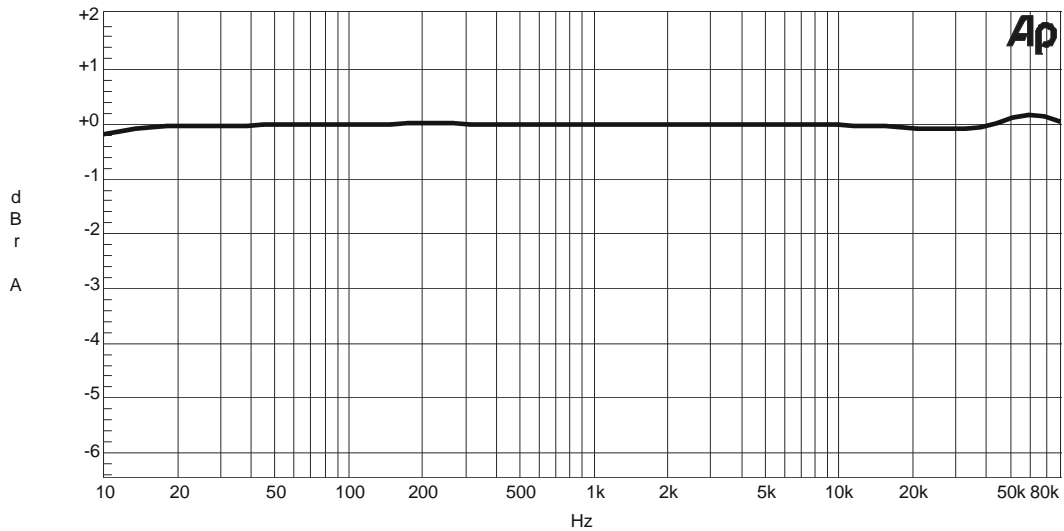

Between 10Hz and 90kHz the frequency response tolerance is within 0.3dB

±

## 10. TECHNICAL DATA, DIAGRAMS

Noise spectrum (1kHz at 10V)

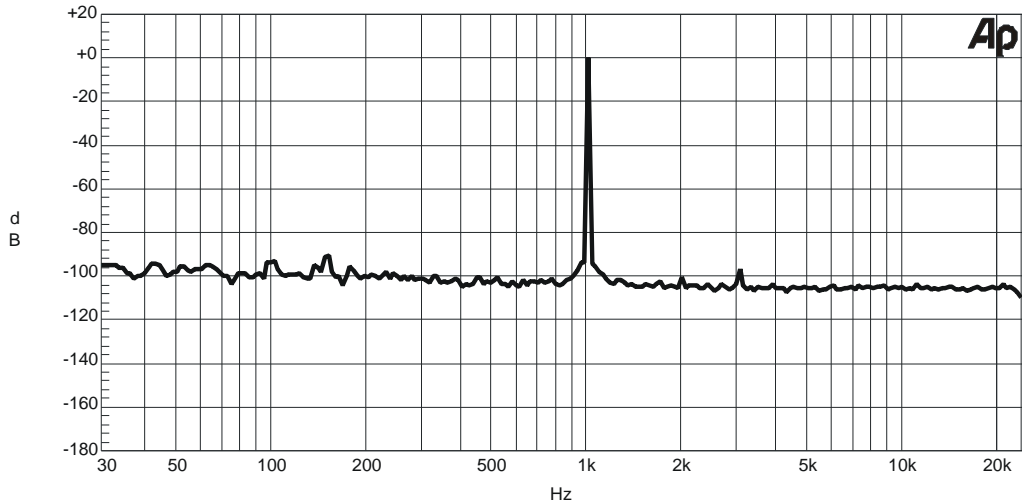

The FFT analysis demonstrates the superb spectral purity of the output signal. No mains-borne noise (normally at 50 and 100Hz) is present

THD between 30Hz and 20kHz

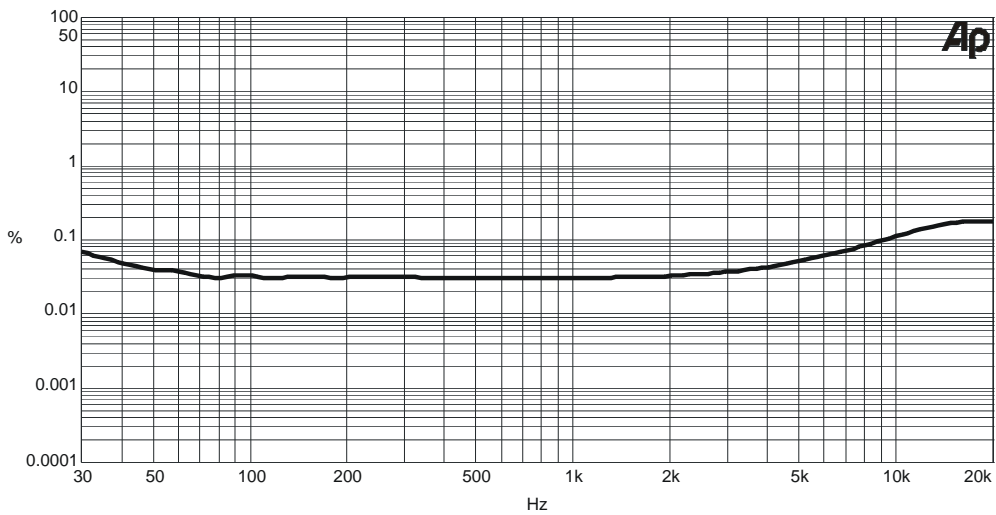

The total harmonic distortion curve is very linear, increasing only slightly at the lowest frequencies. This performance is only possible using a highly specialist output transformer.

## 11. FAQ

---

### 1. Can you operate the amplifier when no loudspeakers are connected?

Yes. All OCTAVE amplifiers are protected against open circuit conditions, i.e. they will not be damaged if operated with the loudspeakers disconnected. However, when connecting your loudspeakers to the amplifier, you should set the volume control on your preamp to 0 to avoid excessive output to the speakers. Protected against open circuit conditions here means without any speakers or speaker cable connected. If you use a "high capacitance" speaker cable, you should make sure you connect the cable first to the speakers and then to the amplifier.

### 2. Can a short circuit on the speaker outputs damage the amplifier?

At low levels, the power amplifier is absolutely short-circuit proof. At higher levels, the electronic protection is activated. Under normal circumstances, a short circuit condition at the speaker outputs will not damage the amplifier.

### 3. How do you recognize a faulty tube? (see Chapt. 6.2.)

There are 3 different symptoms indicating a faulty tube:

1. Broken heater filament: the tube stops glowing
2. Defective cathode layer: the tube glows, but no current can flow. This fault will be shown on the bias display.
3. Short circuit within the tube: This fault will normally trip the electronic protection and cause the red OFF LED to illuminate.

With faults 1 and 2, the amplifier will still operate, although the channel containing the faulty tube will be quieter than normal. At low listening levels, the fault may not be obvious, but distortion will become evident at higher listening levels.

If fault 3 occurs, the protection circuits will normally switch the amplifier off. You may also hear loud background noises just before it switches off, although these will not harm the amplifier.

### 4. Is there a loss of sound quality as tubes age?

No. Tubes normally sound the same throughout their service life. Our soft-start technology contributes greatly to extending the service life of tubes. You can tell when an output tube has reached the end of its useful life: it becomes impossible to adjust it correctly. Driver tubes cannot be checked, but these will generally last for well over 10 years.

### 5. Does the power amplifier have to have all tubes fitted?

The power amplifiers have been designed to operate without a full complement of output tubes for test purposes, or as an interim measure. Power output will, of course, be reduced. Normally, operating the amplifier like this for extended periods will not result in any damage. However, you must not try to run the amplifier at full power.

## 11. FAQ

---

**6. What is the significance of loudspeaker impedance and efficiency?**

The impedance and efficiency of modern loudspeakers is not an issue for OCTAVE amplifiers. The often-quoted damping factor is not normally a guarantee that an amplifier will exert tight control over the loudspeakers. In practice, speakers of 85dB efficiency and above are suitable for use with tube amplifiers. The high stability of the OCTAVE power amplifier technology even allows the use of speakers whose impedance dips as low as 2 ohms.

**7. What is the idea of selectable gain in OCTAVE preamps?**

Speakers with rated efficiencies higher than 98dB are problematic when it comes to adjusting volume levels. As the range of adjustment is limited to the lower end of the volume control, it is difficult to adjust the volume with any precision. The gain switch is provided to deal with this problem. It reduces gain by a factor of 4, making volume adjustment easier and reducing background noise at the same time.

**8. What cables are suitable for tube power amplifiers?**

The cable manufacturers are now offering cables that have supposedly been designed specifically for tube amplifiers. Although such cables may be of good quality, there is no need to use special cables with tube amplifiers. Speaker cable can exhibit high values of capacitance and inductance. Tube power amplifiers deal with such loads better than transistor power amplifiers. The only exception would be in the case of tube preamp to power amp interconnect cable longer than 5 metres. In this instance, a low capacitance cable is advisable.



We reserve the right to alter and improve the specifications in pursuit of better. OCTAVE logo is a registered trade mark of Andreas Hofmann. Copyright by Andreas Hofmann. Reproduction in whole or part is prohibited.  
edited EN2010

OCTAVE AUDIO  
Germany  
[www.octave.de](http://www.octave.de)